

It's Not What You Know, Its What Knot You Know!

Steve Shapiro, Troop 475, Palm Harbor, Fl, sks@sksci.com

Whipping

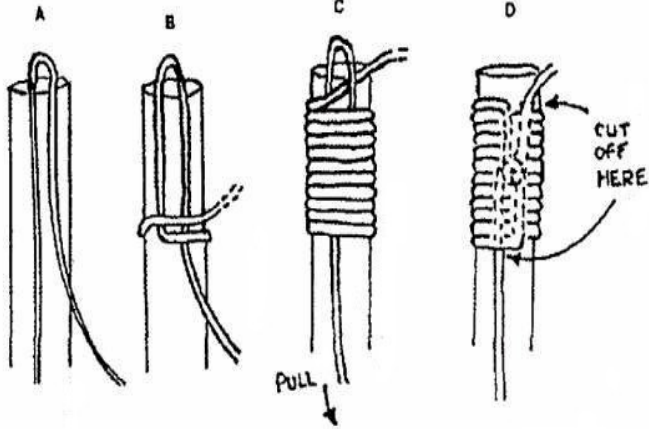

Square Knot

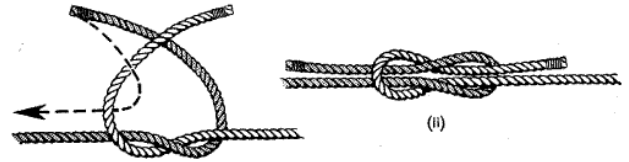

Taut Line Hitch



Bowline

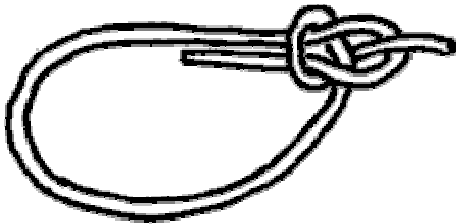

Sheet Bend



Timber Hitch

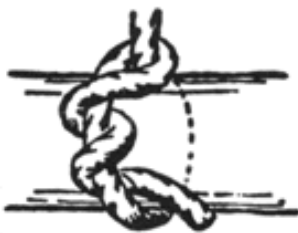

Two Half Hitches



Clove Hitch

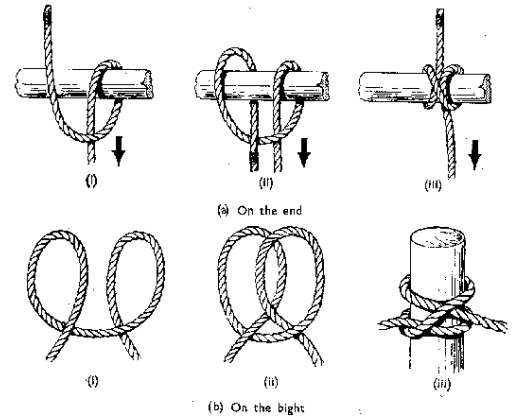

Diagonal Lashing

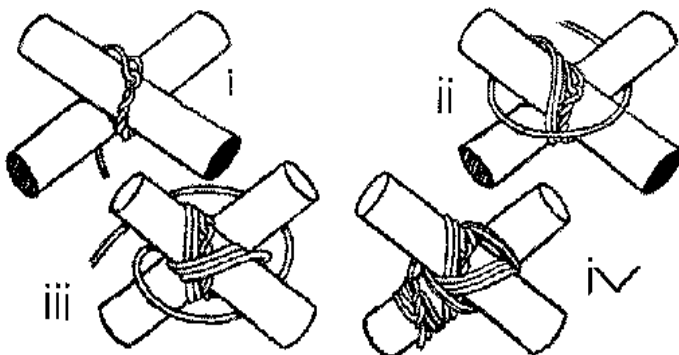

(Clove Hitch may be used to start / end lashing)

Square Lashing

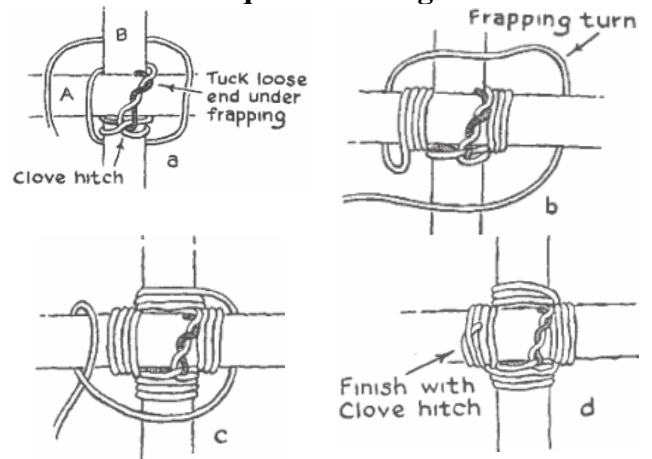

Round Lashing

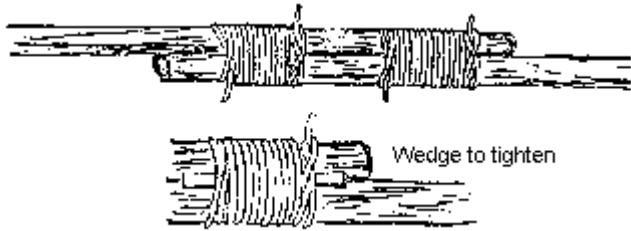

Shear Lashing

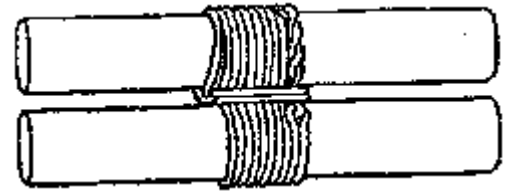

Tripod Top

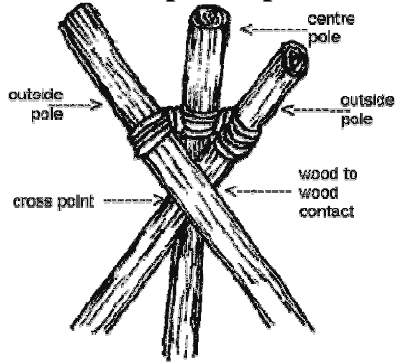

Tripod Pole Layout

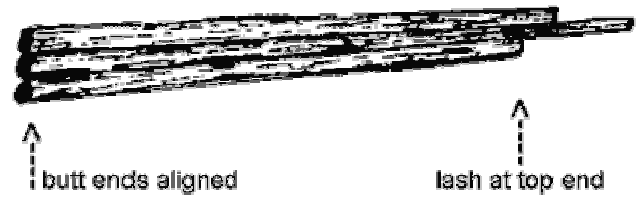

Tripod Lashing Step By Step

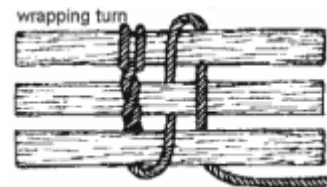
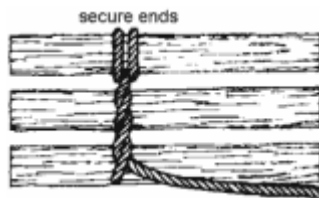

(Clove Hitch may be used to start / end lashing)

